

SIEMENS

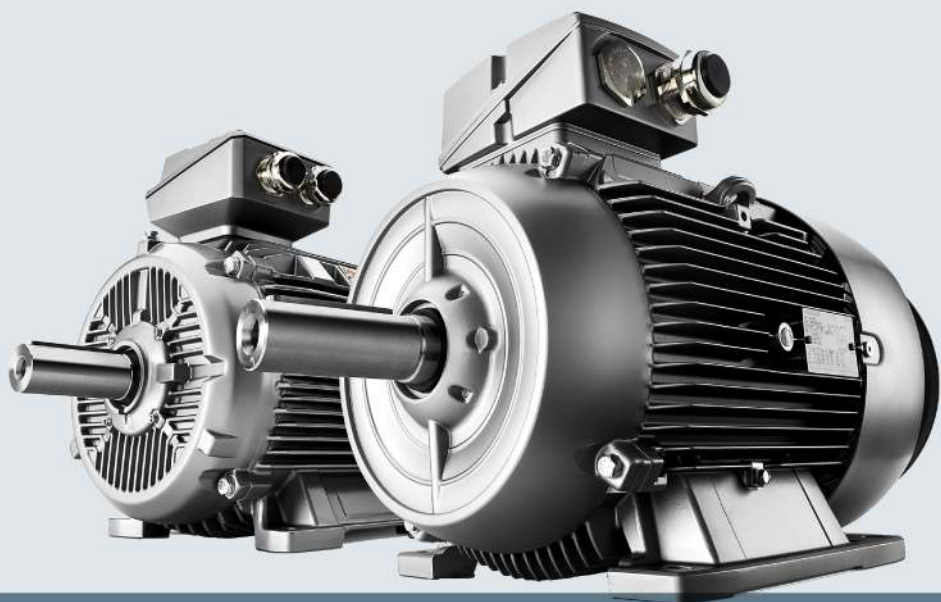

SIMOTICS XP

Low-voltage motors

1LA5/6/7/9, 1MA6/7, 1MB1, 1LG4/6

Compact operating instructions

Edition

01/2016

siemens.com

SIEMENS

SIMOTICS XP

Low-voltage motors

Explosion-protected machines

Compact Operating Instructions

Legal information

Qualified Personnel

The product/system described in this documentation may be operated only by **personnel qualified** for the specific task in accordance with the relevant documentation, in particular its warning notices and safety instructions. Qualified personnel are those who, based on their training and experience, are capable of identifying risks and avoiding potential hazards when working with these products/systems.

Proper use of Siemens products

Note the following:

WARNING

Siemens products may only be used for the applications described in the catalog and in the relevant technical documentation. If products and components from other manufacturers are used, these must be recommended or approved by Siemens. Proper transport, storage, installation, assembly, commissioning, operation and maintenance are required to ensure that the products operate safely and without any problems. The permissible ambient conditions must be complied with. The information in the relevant documentation must be observed.

Warning notice system

This manual contains notices you have to observe in order to ensure your personal safety, as well as to prevent damage to property. The notices referring to your personal safety are highlighted in the manual by a safety alert symbol, notices referring only to property damage have no safety alert symbol. These notices shown below are graded according to the degree of danger.

 DANGER

indicates that death or severe personal injury will result if proper precautions are not taken.
--

 WARNING
--

indicates that death or severe personal injury may result if proper precautions are not taken.

 CAUTION
--

indicates that minor personal injury can result if proper precautions are not taken.
--

NOTICE

indicates that property damage can result if proper precautions are not taken.
--

If more than one degree of danger is present, the warning notice representing the highest degree of danger will be used. A notice warning of injury to persons with a safety alert symbol may also include a warning relating to property damage.

1 Introduction

1.1 Machine types

These instructions are applicable for the following machine types

1LA5/6/7/9, 1MA6/7, 1MB1, 1LG4/6

1.2 Information for the reader



Note for 1LE1, 1FP1, 1MB1, 1PC1, 1PC3 machines



Information about explosion-protected machines

2 Safety notes

2.1 Information for those responsible for the plant or system

This electric machine has been designed and built in accordance with the specifications contained in Directive 2006/95/EC up to April 19, 2016 - and from April 20, 2016 according to Directive 2014/35/EU ("Low-Voltage Directive") and is intended for use in industrial plants. Please observe the country-specific regulations when using the electric machine outside the European Community. Follow the local and industry-specific safety and setup regulations.

The persons responsible for the plant must ensure the following:

- Planning and configuration work and all work carried out on and with the machine is only to be done by qualified personnel.
- The operating instructions must always be available for all work.
- The technical data as well as the specifications relating to the permissible installation, connection, ambient and operating conditions are taken into account at all times.
- The specific setup and safety regulations as well as regulations on the use of personal protective equipment are observed.

Note

Use the services and support provided by the appropriate Service Center (Page 145) for planning, installation, commissioning, and servicing work.

You will find safety instructions in the individual sections of this document. Follow the safety instructions for your own safety, to protect other people and to avoid damage to property.

Observe the following safety instructions for all activities on and with the machine.

2.2 Additional information: Information for plant managers (ATEX)

This machine has been designed and built in accordance with Directive 94/9/EC until April 19, 2016 and from April 20, 2016 in accordance with Directive 2014/34/EU ("Explosion Protection Directive"), and it is intended for use in industrial plants with a potentially explosive atmosphere.

Commissioning in the European Community in accordance with Directive 2006/42/EU ("Machinery Directive") is forbidden until the plant into which the machine will be installed has been shown to conform with this directive. Please observe the country-specific regulations when using the machine outside the European Community.

 WARNING
--

Commissioning prior to establishing conformance
--

If the machine is commissioned prior to determining the plant conformance, the explosion protection of the plant is not ensured. An explosion can occur. This can result in death, serious injury or material damage.

Do not commission the machine until it has been confirmed that the plant conforms with the explosion protection directive.
--

2.3 The five safety rules

For your own personal safety and to prevent material damage when carrying out any work, always observe the safety-relevant instructions and the following five safety rules according to EN 50110-1 "Working in a voltage-free state". Apply the five safety rules in the sequence stated before starting work.

Five safety rules

1. Disconnect the system.
Also disconnect the auxiliary circuits, for example, anti-condensation heating.
2. Secure against reconnection.
3. Verify absence of operating voltage.
4. Ground and short-circuit.
5. Provide protection against adjacent live parts.

To energize the system, apply the measures in reverse order.

2.4 Qualified personnel

All work at the machine must be carried out by qualified personnel only. For the purpose of this documentation, qualified personnel is taken to mean people who fulfill the following requirements:

- Through appropriate training and experience, they are able to recognize and avoid risks and potential dangers in their particular field of activity.
- They have been instructed to carry out work on the machine by the appropriate person responsible.

2.5 Safe handling

Workplace safety depends on the attentiveness, care, and common sense of the personnel who install, operate, and maintain the machine. In addition to the safety measures cited, as a matter of principle, the use of caution is necessary when you are near the machine. Always pay attention to your safety.

Also observe the following to prevent accidents:

- General safety regulations applicable in the country where the machine is deployed.
- Manufacturer-specific and application-specific regulations
- Special agreements made with the operator
- Separate safety instructions supplied with the machine
- Safety symbols and instructions on the machine and its packaging



 **WARNING**

Live parts

Electric machines contain live parts.

Fatal or severe injuries and substantial material damage can occur if the covers are removed or if the machine is not handled, operated, or maintained properly.

- Always observe the "five safety rules" (Page 78) when carrying out any work on the machine.
- Only remove the covers using the methods described by these operating instructions.
- Operate the machine properly.
- Regularly and correctly maintain the machine.



 **WARNING**

Rotating parts

Electric machines contain dangerous rotating parts.

Fatal or severe injuries and substantial material damage can occur if the covers are removed or if the machine is not handled, operated, or maintained properly.

- Only remove the covers using the methods described by these operating instructions.
- Operate the machine properly.
- Perform regular maintenance on the machine.
- Secure free-standing shaft ends.



 **WARNING**

Hot surfaces

Electric machines have hot surfaces. Do not touch these surfaces. They could cause burns.

- Allow the machine to cool before starting work on the machine.
- Only remove the covers using the methods described by these operating instructions.
- Operate the machine properly.



 **CAUTION**

Hazardous substances

Chemical substances required for the setup, operation and maintenance of machines can present a health risk.

Poisoning, skin damage, cauterization of the respiratory tract, and other health damage may result.

- Read the information in these operating instructions and the product information supplied by the manufacturer.
- Observe the relevant safety regulations and wear the personal protective equipment specified.



 **CAUTION**

Flammable substances

Chemical substances required for the setup, operation and maintenance of machines may be flammable.

Burns and other damage to health and material may result.

- Read the information in these operating instructions and the product information supplied by the manufacturer.
- Observe the relevant safety regulations and wear the personal protective equipment specified.



 **WARNING**

Interference to electronic devices caused by electrical power equipment

Electrical power equipment generate electric fields during operation. Potentially lethal malfunctions can occur in medical implants, e.g. pacemakers, in the vicinity of electrical power equipment. Data may be lost on magnetic or electronic data carriers.

- It is forbidden for people with pacemakers to enter the vicinity of the machine.
- Protect the personnel working in the plant by taking appropriate measures, such as erecting identifying markings, safety barriers and warning signs and giving safety talks.
- Observe the nationally applicable health and safety regulations.
- Do not carry any magnetic or electronic data media.

2.6 Interference voltages when operating the converter

 **WARNING**

Interference voltages when operating the converter

When a converter is in operation, the emitted interference varies in strength depending on the converter (manufacturer, type, interference suppression measures undertaken). On machines with integrated sensors (e.g. PTC thermistors), interference voltages caused by the converter may occur on the sensor lead. This can cause faults which can result in eventual or immediate death, serious injury or material damage.

Observe the EMC instructions of the converter manufacturer in order to avoid exceeding the limit values according to IEC/EN 61000-6-3 for drive systems comprising machine and converter. You must put appropriate EMC measures in place.



Note

The increased level of danger in hazardous areas demands that you pay particular attention to the notes marked with .

2.7 Special conditions for explosion-proof machines



Special conditions for the safe use of explosion-protected machines with X marking (excerpt from EC or EU prototype test certificate, Point 17).

Zone 21

- Do not operate the motors with excessively thick deposits of dust.
- When the motors are mounted with the free shaft end pointing upwards, prevent foreign bodies from dropping into the ventilation openings using an appropriate mechanical design.
- For motors with a fixed connecting cable: The free end of the cable must be connected according to valid regulations for electrical installations.

3 Description

Additional languages in the Internet

You can find the operating instructions in other languages on the Internet page: <http://support.industry.siemens.com> (Page 145)

If you require additional language versions, please contact the Siemens Service Center (Page 145).

Intended use of the machines

These machines are intended for industrial installations. They comply with the harmonized standards of the series EN / IEC 60034 (VDE 0530). It is prohibited that these motors are used in hazardous zones if the marking on the rating plate does not explicitly permit line or converter operation. If other/more wide-ranging demands (e.g. protection so that they cannot be touched by children) are made in special cases – i.e. use in non-industrial installations – these conditions must have been complied with in the plant or system itself when the motors are installed.

Note

Machine directive

Low-voltage motors are components designed for installation in machines in accordance with the current Machinery Directive. Commissioning is prohibited until it has been absolutely identified that the end product is in conformance with this Directive. Observe machinery directive EN 60204-1!

3.1 CE marking

Note

Use of machines without CE identification

Machines without  marking are intended for operation outside the European Economic Area (EEA). Do not use any machines without CE mark within of the EEA!

3.2 Regulations

The regulations and standards used as basis to design and test this machine are stamped on the rating plate. The machine design basically complies with the following standards:

Table 3-1 Applicable general regulations

Feature	Standard
Dimensioning and operating behavior	EN / IEC 60034-1
Procedure for determining the losses and the efficiency of rotating electrical machines and inspections	EN / IEC 60034-2-1 EN / IEC 60034-2-2 EN / IEC 60034-2-3
Degree of protection	EN / IEC 60034-5
Cooling	EN / IEC 60034-6
Type of construction	EN / IEC 60034-7
Terminal designations and direction of rotation	EN / IEC 60034-8
Noise emission	EN / IEC 60034-9
Starting characteristics of rotating electrical machines	EN / IEC 60034-12
Vibration severity grades	EN / IEC 60034-14
Efficiency classification of three-phase squirrel-cage induction motors	EN / IEC 60034-30
IEC standard voltages	IEC 60038

3.3 Regulations for explosion-proof machines

Supplementary regulations for explosion-proof machines



Table 3-2 Regulations applied for explosion-protected machines

Feature	Standard
Electrical equipment for hazardous gas atmospheres, Part 0: General requirements	EN / IEC 60079-0
Electrical equipment for hazardous gas atmospheres, Part 7: Increased safety "e"	EN / IEC 60079-7
Electrical equipment for hazardous gas atmospheres, Part 14: Electric installations for endangered atmospheres (except underground excavation)	EN / IEC 60079-14
Electrical equipment for hazardous gas atmospheres, Part 15: Type of protection "n"	EN / IEC 60079-15
Electrical equipment for hazardous gas atmospheres, Part 19: Repairs and overhauls	EN / IEC 60079-19

Feature	Standard
Potentially explosive atmosphere - Part 31: Device dust explosion protection by enclosure "t"	EN / IEC 60079-31
Electrical equipment for use in the presence of combustible dust - Part 17: Inspection and maintenance of electrical systems in hazardous areas (except underground excavation)	EN / IEC 60079-17
Directive on the approximation of the laws of the Member States concerning equipment and protective systems intended for use in hazardous areas.	Directive 94/9/EC (up to April 19, 2016) Directive 2014/34/EU (from April 20, 2016)

3.4 Regulations of the customs union Eurasia

Table 3-3 Applicable general regulations

Feature	Standard	EAC
Dimensioning and operating behavior	EN / IEC 60034-1	GOST R IEC 60034-1
Procedure for determining the losses and the efficiency of rotating electrical machines and inspections	EN / IEC 60034-2-1 EN / IEC 60034-2-2 EN / IEC 60034-2-3	GOST R IEC 60034-2-1 GOST R IEC 60034-2-2 GOST R IEC 60034-2-3
Degree of protection	EN / IEC 60034-5	GOST R IEC 60034-5
Cooling	EN / IEC 60034-6	GOST R IEC 60034-6
Type of construction	EN / IEC 60034-7	GOST R IEC 60034-7
Terminal designations and direction of rotation	EN / IEC 60034-8	GOST R IEC 60034-8
Noise emission	EN / IEC 60034-9	GOST R IEC 60034-9
Starting characteristics of rotating electrical machines	EN / IEC 60034-12	GOST R IEC 60034-12
Vibration severity grades	EN / IEC 60034-14	GOST R IEC 60034-14
Efficiency classification of three-phase squirrel-cage induction motors	EN / IEC 60034-30	GOST R IEC 60034-30
IEC standard voltages	IEC 60038	GOST R IEC 60038

Table 3-4 Regulations applied for explosion-protected machines

Feature	Standard	EAC
Electrical equipment for hazardous gas atmospheres, Part 0: General requirements	EN / IEC 60079-0	GOST 30852 0 - 2002
Electrical equipment for hazardous gas atmospheres, Part 7: Increased safety "e"	EN / IEC 60079-7	GOST 30852 8 - 2002
Electrical equipment for hazardous gas atmospheres, Part 14: Electric installations for endangered atmospheres (except underground excavation)	EN / IEC 60079-14	GOST 30852 13 - 2002
Electrical equipment for hazardous gas atmospheres, Part 15: Type of protection "n"	EN / IEC 60079-15	GOST 30852 14 - 2002
Electrical equipment for hazardous gas atmospheres, Part 19: Repairs and overhauls	EN / IEC 60079-19	GOST 30852 18 - 2002
Potentially explosive atmosphere - Part 31: Device dust explosion protection by enclosure "t"	EN / IEC 60079-31	GOST R IEC 60079-31
Electrical equipment for use in the presence of combustible dust - Part 17: Inspection and maintenance of electrical systems in hazardous areas (except underground excavation)	EN / IEC 60079-17	GOST 30852 16 - 2002
Directive on the approximation of the laws of the Member States concerning equipment and protective systems intended for use in hazardous areas.	Directive 94/9/EC (up to April 19, 2016) Directive 2014/34/EU (from April 20, 2016)	TR CU

3.5 Forced ventilation (optional)

Forced ventilation (optional): Type of cooling IC 416 in accordance with EN / IEC 60034-6

Cooling that does not depend on the speed is achieved by means of a separately driven fan wheel (forced ventilation). Forced ventilation does not depend on the operating state of the machine.

The fan wheel for the external flow of cooling air is powered by an independent module and is enclosed by the fan cover.

3.6 Safety instructions for types of construction/Installation conditions for explosion-proof machines

Types of construction/Installation conditions for explosion-proof machines



The type of construction of the machine is stated on the rating plate.

In the case of explosion-proof machines where the shaft extensions point downwards (types of construction IM V5, IM V1 or IM V18) a protective top cover is mandatory. Explosion-proof machines with IM V5, IM V1 and IM V18 types of construction are fitted with a canopy at the factory.

3.7 Degree of protection

The machine has a type of protection as stamped on the rating plate, and can be installed in dusty or humid environments.



Machines intended for use in Zone 1 (type of protection Flameproof Enclosure "d" or Increased Safety "e") or in Zone 2 (type of protection "n") are designed with IP 55 degree of protection.

Machines intended for use in Zone 21 have IP 65 degree of protection. Machines intended for use in Zone 22 have IP 55 degree of protection and can be used in dusty environments such as grinders, silos, animal feed plants, and malhouses, as well as in certain areas of the chemical industry.

3.8 Environmental conditions

Limit values for the standard version

Relative humidity for ambient temperature T_{amb} 40 °C	Max. 55 %
Ambient temperature	-20 °C to +40 °C
Installation altitude	≤ 1000 m
Air with normal oxygen content, usually	21 % (V/V)

If the environmental conditions are different from the details listed here, then the values on the rating plate will apply.

The machine is suitable for tropical climates.

3.9 Marking explosion-proof machines

Table 3-5 Zone 1 with Ex e IIC Gb type of protection (increased safety "e")



	0158		II	2	G	Ex	e	IIC	T3	Gb
---	------	---	----	---	---	----	---	-----	----	----

Table 3-6 Zone 2 with type of protection Ex nA IIC Gc, (non sparking)



			II	3	G	Ex	nA	IIC	T3	Gc
---	--	---	----	---	---	----	----	-----	----	----

Table 3-7 Zone 21





	0158		II	2	D	Ex	tb	IIIC	T125°C	Db
---	------	---	----	---	---	----	----	------	--------	----

Table 3-8 Zone 22

			II	3	D	Ex	tc	IIIB	T125°C	Dc
---	--	---	----	---	---	----	----	------	--------	----

4 Preparing for use

Good planning and preparation of machine applications are essential in terms of keeping installation simple and avoiding errors, ensuring safe operation, and allowing access to the machine for servicing and corrective maintenance.

This chapter outlines what you need to consider when configuring your plant in relation to this machine and the preparations you need to make before the machine is delivered.

4.1 Safety-related aspects to consider when configuring the plant

A number of residual risks are associated with the machine. These are described in the chapter titled "Safety information" (Page 77) and in related sections.

Take appropriate safety precautions (covers, barriers, markings, etc.) to ensure the machine is operated safely within your plant.

4.2 Observing the operating mode

Observe the machine's operating mode. Use a suitable control system to prevent overspeeds, thus protecting the machine from damage.

4.3 Delivery

Checking the delivery for completeness

The drive systems are put together on an individual basis. When you take receipt of the delivery, please check immediately whether the items delivered are in accordance with the accompanying documents. Siemens will not accept any claims relating to items missing from the delivery and which are submitted at a later date.

- Report any apparent transport damage to the delivery agent immediately.
- Report any apparent defects/missing components to the appropriate SIEMENS office immediately.

Archive the safety and commissioning notes provided in the scope of delivery as well as the optionally available operating instructions so that these documents are always easily accessible.

The rating plate optionally enclosed as a loose item with the delivery is provided to enable the motor data to be attached on or near the machine or installation.

4.4 Transport and storage

When carrying out any work on the machine, observe the general safety instructions (Page 77) and the specifications contained in EN 50110-1 regarding safe operation of electrical equipment.

 **WARNING**

Risk of dropping and swinging when transported suspended

If you transport the motor suspended from cables or ropes, the cables or ropes can break, e.g. as a result of damage. Further, if not adequately attached, the motor can swing. This can result in death, serious injury, or material damage.

- Use additional, suitable lifting equipment for transport and during installation.
- Two cables alone must be able to carry the complete load.
- Prevent the lifting equipment from sliding by appropriately securing it.

 **WARNING**

Toppling over or slipping of the motor

The motor can slide or topple over if it is not correctly lifted or transported. This can result in death, serious injury, or material damage.

- Use all the lifting eyes on the machine.
- When using the lifting eyes on the machine, do not attach any additional loads or weight. The lifting eyes are only designed for the weight of the machine itself.
- Any eyes that are screwed in must be tightly fastened.
- Eyebolts must be screwed in right up to their supporting surface.
- Comply with the permissible eyebolt loads.
- When necessary, use suitably dimensioned transport equipment, for example hoisting straps (EN1492-1) and load restraints (EN12195-2).

Note

When lifting the machines for transport, only lift them in a position that corresponds to their basic construction type.

The type of construction of the machine is stated on the rating plate.

4.4.1 Storage

Storing outdoors

NOTICE**Damage to the motor**

Damage can occur if incorrectly stored.

Take all precautions to protect the motor under extreme climatic conditions, e.g. salt-laden and/or dusty, moist/humid atmospheres.

Choose a dry storage location which is safe from flooding and free from vibration. Repair any damage to the packaging before putting the equipment into storage if this is necessary to ensure proper storage conditions. In order to ensure protection against ground moisture, locate machines, equipment and crates on pallets, wooden beams or foundations. Prevent equipment from sinking into the ground. Do not impede air circulation under the stored items.

Covers or tarpaulins used to protect the equipment against the weather must not come into contact with the surfaces of the equipment. Use wooden spacer elements to ensure that air can circulate freely around the equipment.

Storing indoors

The storage rooms must provide protection against extreme weather conditions. They must be dry, free from dust, frost and vibration and well ventilated.

Bare metal surfaces

For transport, the bare surfaces (shaft ends, flange surfaces, centering edges) should be coated with an anti-corrosion agent which will last for a limited amount of time (<6 months). Apply suitable anti-corrosion measures for longer storage times.

Condensation drain hole

Open any condensation drain holes to drain the condensation depending on the environmental conditions, every six months at the latest.

4.5 Explosion hazard during commissioning, if stored incorrectly



WARNING

Risk of explosion due to damaged sealing materials

Storing the machine at temperatures that do not fall within the specified limits can damage the material of the seals and cause them to fail. As a result, a potentially explosive gaseous atmosphere can enter the machine and be ignited during commissioning. Explosions can occur. This can result in death, serious injury or material damage.

The materials used are specially designed for the temperature range required by the customer. Do not store the motor in conditions that lie outside the specified temperature limits. The relevant temperature limits are specified on the rating plate.

Storage temperature

Permissible temperature range: -20 °C to +50 °C

The relative humidity of the air should be less than 60 %.

For machines that have a special design regarding the coolant temperature in the operating state or the installation altitude, other conditions could apply regarding the storage temperature. In this case, refer to the machine rating plate for data on the coolant temperature and installation altitude.

Storage time

Turn the shafts 1x every year to avoid bearing brinelling. Prolonged storage periods reduce the useful life of the bearing grease (aging).

Open bearings

- For open bearings, e.g. 1Z, check the status of the grease when stored for longer than 12 months.
- Replace the grease if it is identified that the grease has lost its lubricating properties or is polluted. The consistency of the grease will change if condensation is allowed to enter.

Closed bearings

- For sealed bearings, replace the DE and NDE bearings after a storage time of 48 months.

NOTICE

Storage

The motor can be damaged if you use it or store it unprotected outdoors.

- Protect the motor against intensive solar radiation, rain, snow, ice and dust. Use a superstructure or additional cover, for example.
- If required, contact the Siemens Service Center, or technically coordinate outdoors use.

4.6 Electromagnetic compatibility

Note

If the torque levels are very unequal (e.g. when a reciprocating compressor is being driven), a non-sinusoidal machine current will be induced whose harmonics can have an impermissible effect on the supply system and cause impermissible interference emissions as a result.

Note

Converter

- If operated with a frequency converter, the emitted interference varies in strength, depending on the design of the converter (type, interference suppression measures, manufacturer).
- Avoid that the specified limit values stipulated for the drive system (consisting of the motor and converter) are exceeded.
- You must observe the EMC information from the manufacturer of the converter.
- The most effective method of shielding is to conductively connect a shielded machine supply cable to the metal terminal box of the machine (with a metal screw connection) over a large surface area.
- On machines with integrated sensors (e.g. PTC thermistors), disturbance voltages caused by the converter may occur on the sensor cable.

4.7 Converter operation

4.7.1 Parameterizing the converter

- If the design of the motor requires connection to a particular converter type, the rating plate will contain corresponding additional information.
- Correctly parameterize the converter. Parameterizing data can be taken from the machine rating plate (not the supplementary rating plate with the operating data when connected to a converter).
You can find parameter data here:
 - In the operating instructions for the converter.
 - In the SIZER engineering tool
 - In the SINAMICS Configuration Manuals.
 - For explosion-protected machines, also in the declaration of compliance with the order 2.1.
- Do not exceed the specified maximum speed limit n_{\max} . You can either find this on the rating plate n_{\max} , under the supplementary plate for converter operation as the highest speed, or in Catalog D81.1.
- Check that it is guaranteed that the machine is cooled for commissioning.

4.7.2 Reducing bearing currents during operation with converter (low voltage)

Taking the following actions will reduce the bearing currents:

- Ensure that the contacts are established over a large area. Solid copper cables are not suitable for high frequency grounding because of the skin effect.

Equipotential bonding conductors:

Use equipotential bonding conductors:

- Between motor and driven machine
- Between motor and converter
- Between the terminal box and the RF grounding point at the motor enclosure.

Selecting and connecting the cable:

As far as possible, use symmetrically arranged, shielded connection cables. The cable shielding, made up of as many strands as possible, must have good electrical conductivity. Braided shields made of copper or aluminum are very suitable.

- The shield is connected at both ends, at the motor and converter.

- To ensure good discharging of high-frequency currents, provide contacting over a large surface area:
 - as contact established through 360° at the converter
 - at the motor, for instance with EMC glands at the cable entries
- If the cable shield is connected as described, then it ensures the specified equipotential bonding between the motor enclosure and converter. A separate RF equipotential bonding conductor is then not necessary.

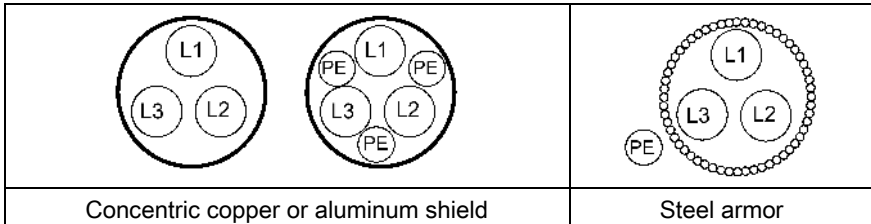

- If the cable shield is not connected due to special secondary conditions, or not adequately connected, then the specified equipotential bonding is not provided. In this particular case, use a separate RF equipotential bonding conductor:
 - Between the motor enclosure and protective ground rail of the converter.
 - Between motor enclosure and driven machine
 - Use braided flat copper straps or high-frequency cables with finely-stranded conductors for the separate RF equipotential bonding cable. Solid copper cables are not suitable for high frequency grounding because of the skin effect.
 - Ensure that the contacts are established over a large area.

Overall system design

To specifically reduce and prevent damage caused by bearing currents, you must consider the system as a whole, which comprises the motor, converter, and driven machine. The following precautions help to reduce bearing currents:

- In the overall system, set up a properly meshed grounding system with low impedance.
- Use the common-mode filter (damping cores) at the converter output. The Siemens sales representative is responsible for selection and dimensioning.
- Limit the rise in voltage by using output filters. This dampens the harmonic content in the output voltage.

Note

Converter documentation

The operating instructions for the converter are not part of this documentation. Refer also to the configuration information for the converter.

4.7.3 Insulated bearings when operated with a converter

If the machine is operated from a low-voltage converter, insulated bearings are fitted at the NDE and an insulated encoder with insulated bearings (option).

Comply with the plates on the machine relating to bearing insulation and possible bridges.

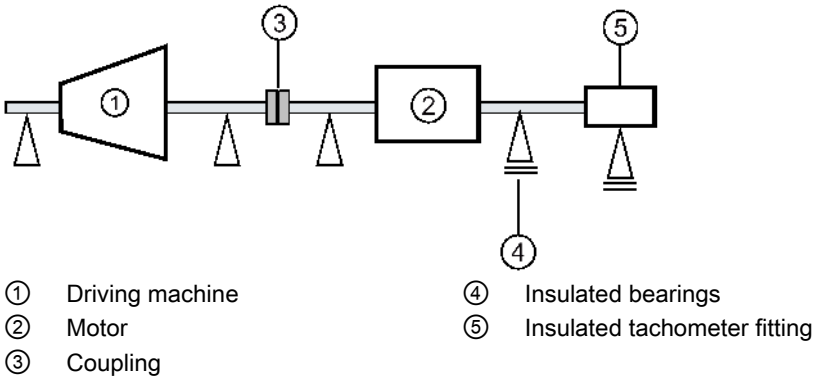

Figure 4-1 Schematic representation of a single drive

<p>NOTICE</p>
<p>Bearing damage</p> <p>The bearing insulation must not be bridged. Damage may be caused to the bearings if there is a flow of current.</p> <ul style="list-style-type: none">• Also for subsequent installation work, such as the installation of an automatic lubrication system or a non-insulated vibration sensor, make sure that the bearing insulation cannot be bridged.• Contact the Service Center, if necessary.

Tandem operation

If you connect two motors in series in "tandem operation", install an insulated coupling between the motors.

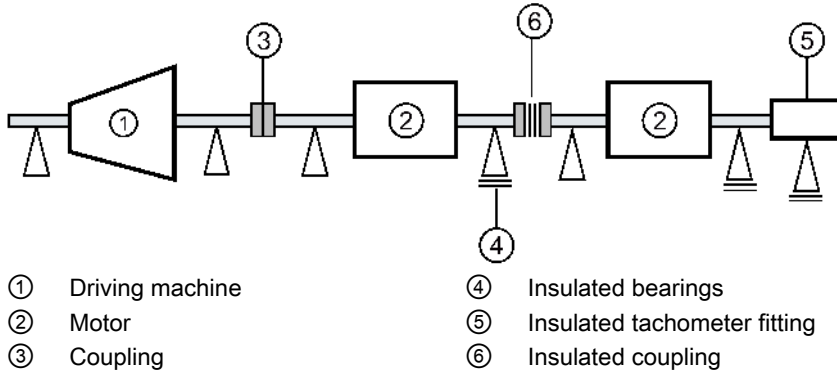

Figure 4-2 Schematic representation of a tandem drive

NOTICE

Bearing damage

If the coupling between the motors of the tandem drive is not insulated, bearing currents can cause damage to the drive-end bearings of both motors.

Use an insulated coupling to link the motors.

4.7.4 Operation with insulated coupling (EX)

If you connect two motors in series in "tandem operation", fit a coupling between the motors; this coupling should satisfy the ATEX Directive or the regulations that apply in the country where the equipment is installed.

5 Installation

When carrying out any work on the machine, observe the general safety instructions (Page 77) and the specifications contained in EN 50110-1 regarding safe operation of electrical equipment.

Note

Loss of conformity with European directives

In the delivery state, the machine corresponds to the requirements of the European directives. Unauthorized changes or modifications to the machine lead to the loss of conformity with European directives and the loss of warranty.



 WARNING
--

Explosion hazard when making modifications to the machine
--

Substantial modifications to the machine are not permitted – or may only be performed by the manufacturer. Otherwise an explosion can occur in an explosive atmosphere. This can result in death, serious injury or material damage.
--

Please contact the Service Center, if necessary.
--

5.1 Preparing for installation

5.1.1 Requirements for installation

The following requirements must be satisfied prior to starting installation work:

- Staff have access to the operating and installation instructions.
- The machine is unpacked and ready for mounting at the installation location.

Note

Measure the insulation resistance of the winding before starting installation work

Wherever possible, measure the insulation resistance of the winding before starting installation work. If the insulation resistance lies below the specified value, take appropriate remedial measures. These remedial measures may necessitate the machine being removed again and transported.

Note

Note also the technical data on the rating plates on the motor enclosure.

NOTICE**Damage to the motor**

To avoid material damage, before commissioning, check whether the correct direction of rotation of the machine has been set on the customer side, e.g. by decoupling from the driven load.



Note

The increased level of danger in hazardous areas demands that you pay particular attention to the notes marked with .

5.1.2 Insulation resistance

5.1.2.1 Insulation resistance and polarization index

Measuring the insulation resistance and polarization index (PI) provides information on the condition of the machine. It is therefore important to check the insulation resistance and the polarization index at the following times:

- Before starting up a machine for the first time
- After an extended period in storage or downtime
- Within the scope of maintenance work

The following information is provided regarding the state of the winding insulation:

- Is the winding head insulation conductively contaminated?
- Has the winding insulation absorbed moisture?

As such, you can determine whether the machine needs commissioning or any necessary measures such as cleaning and/or drying the winding:

- Can the machine be put into operation?
- Must the windings be cleaned or dried?

Detailed information on testing and the limit values can be found here:

"Testing the insulation resistance and polarization index" (Page 100)

5.1.2.2 Testing the insulation resistance and polarization index



 **WARNING**

Hazardous voltage at the terminals

During and immediately after measuring the insulation resistance or the polarization index (PI) of the stator winding, hazardous voltages may be present at some of the terminals. Contact with these can result in death, serious injury or material damage.

- If any power cables are connected, check to make sure line supply voltage cannot be delivered.
- Discharge the winding after measurement until the risk is eliminated, e.g. using the following measures:
 - Connect the terminals with the ground potential until the recharge voltage drops to a non-hazardous level
 - Attach the connection cable.

Measure the insulation resistance

1. Before you begin measuring the insulation resistance, please read the operating manual for the insulation resistance meter you are going to use.
2. Make sure that no power cables are connected.
3. Measure the winding temperature and the insulation resistance of the winding in relation to the machine enclosure. The winding temperature should not exceed 40° C during the measurement. Convert the measured insulation resistances in accordance with the formula to the reference temperature of 40° C. This thereby ensures that the minimum values specified can be compared.
4. Read out the insulation resistance one minute after applying the measuring voltage.

Limit values for the stator winding insulation resistance

The following table specifies the measuring voltage and limit values for the insulation resistance. These values correspond to IEEE 43-2000 recommendations.

Table 5-1 Stator winding insulation resistance at 40° C

V_N [V]	V_{Meas} [V]	R_c [MΩ]
$U \leq 1000$	500	≥ 5
$1000 \leq U \leq 2500$	500 (max. 1000)	100
$2500 < U \leq 5000$	1000 (max. 2500)	
$5000 < U \leq 12000$	2500 (max. 5000)	
$U > 12000$	5000 (max. 10000)	

U_{rated} = rated voltage, see the rating plate

U_{meas} = DC measuring voltage

R_c = minimum insulation resistance at reference temperature of 40° C

Conversion to the reference temperature

When measuring with winding temperatures other than 40° C, convert the measuring value to the reference temperature of 40° C according to the following equations from IEEE 43-2000.

(1) $R_C = K_T \cdot R_T$	R_C	Insulation resistance converted to 40° C reference temperature
	k_T	Temperature coefficient according to equation (2)
	R_T	Measured insulation resistance for measuring/winding temperature T in °C
(2) $K_T = (0.5)^{(40-T)/10}$	40	Reference temperature in °C
	10	Halving/doubling of the insulation resistance with 10 K
	T	Measuring/winding temperature in °C

In this case, doubling or halving the insulation resistance at a temperature change of 10 K is used as the basis.

- The insulation resistance halves every time the temperature rises by 10 K.
- The resistance doubles every time the temperature falls by 10 K.

For a winding temperature of approx. 25° C, the minimum insulation resistances are 20 MΩ ($U \leq 1000$ V) or 300 MΩ ($U > 1000$ V). The values apply for the complete winding to ground. Twice the minimum values apply to the measurement of individual assemblies.

- Dry, new windings have an insulation resistance of between 100 and 2000 MΩ, or possibly even higher values. An insulation resistance value close to the minimum value could be due to moisture and/or dirt accumulation. The size of the winding, the rated voltage and other characteristics affect the insulation resistance and may need to be taken into account when determining measures.
- Over its operating lifetime, the motor winding insulation resistance can drop due to ambient and operational influences. Calculate the critical insulation resistance value depending on the rated voltage by multiplying the rated voltage (kV) by the specific critical resistance value. Convert the value for the current winding temperature at the time of measurement, see above table.

Measuring the polarization index

1. To determine the polarization index, measure the insulation resistances after one minute and ten minutes.
2. Express the measured values as a ratio:

$$PI = R_{\text{insul } 10 \text{ min}} / R_{\text{insul } 1 \text{ min}}$$

Many measuring devices display these values automatically following the measurement.

For insulation resistances > 5000 MΩ, the measurement of the PI is no longer meaningful and consequently not included in the assessment.

$R_{(10 \text{ min})} / R_{(1 \text{ min})}$	Assessment
≥ 2	Insulation in good condition
< 2	Dependent on the complete diagnosis of the insulation

NOTICE
<p>Damage to insulation</p> <p>If the critical insulation resistance is reached or undershot, this can damage the insulation and cause voltage flashovers.</p> <ul style="list-style-type: none"> • Contact the Service Center (Page 145). • If the measured value is close to the critical value, you must subsequently check the insulation resistance at shorter intervals.

Limit values of the anti-condensation heating insulation resistance

The insulation resistance of the anti-condensation heating with respect to the machine housing should not be lower than 1 MΩ when measured at 500 V DC.

5.2 Installation

5.2.1 Installation of explosion-proof machines

- Only use explosion-protected machines in appropriate areas in accordance with directive 1999/92/EG .
If the certification is supplemented by an X, please note the special conditions in the EC type test certificate.Special conditions for explosion-proof machines (Page 82)
- When installing electrical systems in hazardous zones, observe EN / IEC 60079-14 and the corresponding country regulations.
- The machine temperature class specified on the rating plate must be equal to or greater than the temperature class of any combustible gases that may develop.
- At the completely installed drive system, investigate the influence of heat and cold sources on mounted components according to EN 60079-14.

Recommended maximum interface temperatures for flange-mounted motors:

Type of protection	Ex e, Ex nA	
Supply voltage	Line supply	
Control range	-	
Cooling method	Self-cooled	
Frame size	63 ... 200	
Mechanical design	EN 50347	
Ambient temperature	-20 °C ... +40 °C	
Temperature class	T3	
No. of poles	2	4
Max. shaft temperature	60 °C	75 °C
Max. flange temperature	60 °C	75 °C

- Select mounted equipment such as brakes, external fans or incremental encoders according to the requirements of Directive 94/9/EC up to April 19, 2016 – or from April 20, 2016, Directive 2014/34/EU.

5.2.2 Cooling

 WARNING
<p>Overheating and failure of the motor</p> <p>Death, severe injury or material damage can occur if you do not carefully observe the following points.</p> <ul style="list-style-type: none"> • Do not obstruct ventilation. • Prevent the air expelled by neighboring equipment from being immediately sucked in again. • For machines with a vertical type construction with air entry from above, prevent the ingress of foreign bodies and water in the air entry openings (standard IEC / EN 60079-0). • If the shaft extension is facing upwards, liquid must be prevented from entering by moving along the shaft.

 WARNING
<p>Damage caused by small parts falling in</p> <p>Material damage and injury can occur if the fan is destroyed and therefore the motor overheats.</p> <ul style="list-style-type: none"> • For types of construction with the shaft extension facing downwards, prevent small parts from falling into the fan cover by providing suitable covers (standard IEC / EN 60079-0). • Prevent the cooling airflow from being reduced as a result of covers that might be in place.

Table 5-2 Minimum dimension "X" for the distance between neighboring modules and the air intake of the machine

Frame size	X [mm]
63 ... 71	15
80 ... 100	20
112	25
132	30
160	40
180 ... 200	90
225 ... 250	100
280 ... 315	110

5.2.3 Balancing

The rotor is dynamically balanced. The balancing quality corresponds to vibration severity grade "A" for the complete machine as standard. The optional vibration severity grade "B" is indicated on the rating plate.

The declaration regarding the type of featherkey for balancing is generally marked on the rating plate and optionally on the face of the shaft end.

Designation:

- As a standard measure, balancing is carried out dynamically with a half featherkey (code "H") in accordance with ISO 8821.
- "F" means balancing with a whole featherkey (optional version).
- "N" means balancing without a featherkey (optional version).

CAUTION

Incorrect installation or removal

To avoid injury and material damage, carefully observe general touch protection measures for output transmission elements:

- The general touch protection measures for drive output elements must be observed.
- Drive output elements may only be pushed on or pulled off with the correct equipment.
- The feather keys are only locked against falling out during shipping. If you commission a machine without a drive output element, the feather keys must be secured to prevent them from being thrown out.

Align the offset at the coupling between electrical machines and the driven machines so that the maximum permissible vibration values according to ISO 10816 are not exceeded.

5.3 Alignment and mounting

Observe the following when aligning and mounting:

- Ensure a flat and uniform contact surface for foot and flange mounting.
- Precisely align the machine when couplings are used.
- Ensure that the mounting surfaces are clean and free of any dirt.
- Remove any anti-corrosion protection using white spirit.
- Avoid installation-related resonances with the rotating frequency and twice the line frequency.
- Note any unusual noise when the rotor is manually turned.
- Check the direction of rotation with the motor uncoupled.
- Avoid rigid couplings.
- Repair any damage to the paint, this must be done immediately and correctly.



Note

Repainting/touching up the paint finish of explosion-protected machines

For explosion-protected machines, observe the information in Chapter Repainting/touching up (Page 135).

Frame size	Flatness [mm]
≤ 132	0.10
160	0.15
≥ 180	0.20

6 Electrical connection

When carrying out any work on the machine, observe the general safety instructions (Page 77) and the specifications contained in EN 50110-1 regarding safe operation of electrical equipment.

6.1 Connecting the machine



 **DANGER**

Hazardous voltages

Death, injury or material damage can occur. Note the following safety information before connecting-up the machine:

- Only qualified and trained personnel should carry out work on the machine while it is stationary.
- Disconnect the machine from the power supply and take measures to prevent it being reconnected. This also applies to auxiliary circuits.
- Check that the machine really is in a no-voltage condition.
- Establish a safe protective conductor connection before starting any work.
- If the incoming power supply system displays any deviations from the rated values in terms of voltage, frequency, curve form or symmetry, such deviations will increase the temperature and influence electromagnetic compatibility.
- Operating the machine on a line supply system with a non-grounded neutral point is only permitted over short time intervals that occur rarely, e.g. the time leading to a fault being eliminated (ground fault of a cable, EN 60034-1).



All cable glands and blanking plugs must be implemented according to Directive 94/9/EC up to April 19, 2016 - or from April 20, 2016, Directive 2014/34/EU. They must also be certified for use in hazardous zones.

- Any openings that are not being used must be sealed using the appropriate certified blanking plugs.
- Please observe the manufacturer's specifications when fitting cable glands.



The following features make this type of electrical connection different from that for standard machines:

- For machines marked with Zone A, maintain area A in EN / IEC 60034-1 (VDE 0530-1) ($\pm 5\%$ voltage or $\pm 2\%$ frequency deviation, waveform, line supply symmetry) so that the temperature rise remains within the permissible limits.
- Larger deviations from the rated data may result in electrical machines heating up to impermissible levels. This information must be specified on the rating plate. Under no circumstances exceed the limits!
- Protect every machine with type of protection increased safety "e" or protection afforded by the enclosure "t" in accordance with EN / IEC 60079-14 against an inadmissible temperature rise using a current-dependent, delayed circuit breaker with phase failure protection and asymmetry detection corresponding to EN / IEC 60947 or using an equivalent device in all phases.
- For machines with type of protection increased safety "e", select the overcurrent device with current-dependent delayed trip so that the tripping time, which should be taken from the characteristic of the switch for the ratio I_A / I_N of the machine to be protected, is no longer than the safe-locked rotor time t_E . Take the ratio I_A / I_N as well as the safe-locked rotor time t_E from the rating plate. Set the protective device to the rated current. Up to April 19, 2016, use a tripping unit certified to Directive 94/9/EC - and from April 20, 2016, Directive 2014/34/EU.
- For machines with increased safety "e" type of protection, in the event of a locked rotor the protective device must disconnect within the t_E time specified for the relevant temperature class. Protect electric machines used for heavy duty starting (acceleration time $> 1.7 \times t_E$ time - locked rotor time) by monitoring the starting process using suitable equipment corresponding to the data provided in the EC or EU type examination certificate.
Direct monitoring of the winding temperature is permissible as a means of thermal machine protection, provided that this is certified and specified on the rating plate.
- With pole-changing machines, separate, interlocked protective devices are required for each speed step. Equipment with EC or EU type examination certificate are recommended.

6.1.1 Terminal box



 **DANGER**

Hazardous voltage

Electric motors have high voltages. When incorrectly handled, this can result in death or severe injury.

Switch off the machine so that it is in a no-voltage condition before you open the terminal box.

NOTICE

Damage to the terminal box

If you incorrectly carry out work on or in the terminal box, this can result in material damage. You must observe the following to avoid damaging the terminal box:

- Ensure that the components inside the terminal box are not damaged.
- It must be ensured that there are no foreign bodies, dirt or moisture in the terminal box.
- Close the terminal box using the original seal so that it is dust tight and water tight.
- Use O-rings or suitable flat gaskets to seal entries in the terminal box (DIN 42925) and other open entries.
- Please observe the tightening torques for cable glands and other screws.
- When performing a test run, secure the feather keys without output elements.

6.1.1.1 Connection with cable lug for explosion-protected machines



 **WARNING**

Short-circuit hazard

Live conductors released from the terminal board can cause short circuits. Death or serious injury can result.

- You must bend single-core line conductors into a U shape in order to prevent the contact force being transferred at just one side.
- In order to prevent the cable lug from rotating, for a line connection using a cable lug, angle single- or multi-core cables downwards through an angle of approx. 40°.

See also

Type of conductor connection (Page 118)

6.1.1.2 Protruding connection cables



! WARNING

Risk of short-circuit and voltage hazard

A short circuit can occur if connecting cables are clamped and crushed between parts of the enclosure and the cover plate.

This can result in death, severe injury and material damage.

- During disassembly and particularly when installing the cover plate, make sure that the connecting cables are not clamped between enclosure parts and the cover plate.



! CAUTION

Damage to connecting cables that are freely led out

You must observe the following note to avoid damaging connecting cables that are freely led out:

- It must be ensured that there are no foreign bodies, dirt, or moisture in the terminal base of the machine enclosure.
- Use O-rings or suitable flat gaskets to seal entries in cover plates (DIN 42925) and other open entries.
- Seal the terminal base of the machine enclosure using the original seal of the cover plate to prevent dust and water from entering.
- Please observe the tightening torques for cable glands and other screws.

6.1.1.3 Thread sizes



Table 6-1 Thread sizes in the cast iron terminal box

Frame size	Type	Type of protection / Zone	Standard thread		Additional thread with mounting parts	
			Size	Number	Size	Number
71 ... 90	1MB1	Non sparking "n"	M 25x1.5	1	-	-
		Zone 21	M 16x1.5	1		
		Zone 22				

Frame size	Type	Type of protection / Zone	Standard thread		Additional thread with mounting parts	
100 ... 132	1LA6	Non-sparking "n"	M 32x1.5	2	M 16x1.5	1
		Zone 22				
	1MA6	Increased safety "e"				
	1MB1	Non-sparking "n"				
		Zone 21				
Zone 22						
160	1LA6	Non-sparking "n"	M 40x1.5	2	M 16x1.5	1
		Zone 22				
	1MA6	Increased safety "e"				
	1MB1	Non-sparking "n"				
		Zone 21				
Zone 22						
180	1MA6	Increased safety "e"	M 40x1.5	2	M 16x1.5	2
	1LG4	Non-sparking "n"				
	1LG6	Zone 21				
	1MB1	Zone 22				
200	1MA6	Increased safety "e"	M 50x1.5	2	M 16x1.5	2
	1LG4	Non-sparking "n"				
	1LG6	Zone 21				
	1MB1	Zone 22				
225	1MA6	Increased safety "e"	M 50x1.5	2	M 20x1.5	2
	1LG4	Non-sparking "n"				
	1LG6	Zone 21				
	1MB1	Zone 22				
250 ... 315	1MA6	Increased safety "e"	M63 x 1.5	2	M 20x1.5	2
	1LG4	Non-sparking "n"				
	1LG6	Zone 21				
	1MB1	Zone 22				



Table 6-2 Thread sizes in the aluminum terminal box

Frame size	Type	Type of protection / Zone	Standard thread		Additional thread with mounting parts	
			Size	Number	Size	Number
63 ... 90	1LA7 1LA9 1MA7	Increased safety "e"	M 16 x 1.5	1	-	-
		Non sparking "n"	M 25 x 1.5	1		
		Zone 21				
		Zone 21				
80 ... 90	1MB1	Non-sparking "n"	M 16 x 1.5	1	-	-
		Zone 21	M 25 x 1.5	1		
		Zone 21				
100 ... 132	1LA7 1LA9 1MA7	Increased safety "e"	M 32x1.5	4	-	-
		Non sparking "n"				
		Zone 21				
		Zone 22				
100 ... 132	1MB1	Non sparking "n"	M 32x1.5	2	M 16x1.5	1
		Zone 21				
		Zone 22				
160	1LA7 1LA9 1MA7	Increased safety "e"	M 40x1.5	4	-	-
		Non sparking "n"				
		Zone 21				
		Zone 22				
160	1MB1	Non sparking "n"	M 40x1.5	2	M 16x1.5	1
		Zone 21				
		Zone 22				
180	1LA5	Zone 21	M 40x1.5	2	M 16x1.5	1
		Zone 22				

Frame size	Type	Type of protection / Zone	Standard thread		Additional thread with mounting parts	
180	1LG4 1LG6	Non sparking "n"	M 40x1.5	2	M 20x1.5	2
		Zone 21				
		Zone 22				
180	1MA6	Increased safety "e"	M 40x1.5	2	M 16x1.5	2
200 ... 225	1LA5	Zone 21	M 50x1.5	2	M 16x1.5	1
		Zone 22				
200	1MA6	Increased safety "e"	M 50x1.5	2	M 16x1.5	2
200	1LG4 1LG6	Non sparking "n"	M 50x1.5	2	M 20x1.5	2
		Zone 21				
		Zone 22				
225	1LG4 1LG6 1MA6	Increased safety "e"	M 50x1.5	2	M 20x1.5	2
		Non sparking "n"				
		Zone 21				
		Zone 22				

6.2 Tightening torques

6.2.1 Electrical connections - Terminal board connections

Table 6-3 Tightening torques for electrical connections on the terminal board

	Thread Ø		M 3,5	M 4	M 5	M 6	M 8	M 10	M 12	M 16
	Nm	min	0,8	0,8	1,8	2,7	5,5	9	14	27
		Ma x.	1,2	1,2	2,5	4	8	13	20	40

6.2.2 Cable glands

Note

Avoid damaging the cable jacket.

Adapt the tightening torques to the cable jacket materials.

You should refer to the table in order to find the correct tightening torque for any metal and plastic cable glands that are to be mounted directly on the machine, as well as for any other screw-type connections (such as adapters).

Table 6-4 Tightening torques for cable glands

	Metal ± 10% [Nm]	Plastic ± 10% [Nm]	Clamping range [mm]		O ring Cord dia. [mm]
			Standard -30 °C ... 100 °C Ex -30 °C ... 90 °C	Ex -60 °C ... 90 °C	
M 12 x 1.5	8	1.5	3.0 ... 7.0	-	2
M 16 x 1.5	10	2	4.5 ... 10.0	6.0 ... 10.0	
M 20 x 1.5	12	4	7.0 ... 13.0	6.0 ... 12.0	
M 25 x 1.5			9.0 ... 17.0	10.0 ... 16.0	
M 32 x 1.5	18	6	11.0 ... 21.0	13.0 ... 20.0	
M 40 x 1.5	20		19.0 ... 28.0	20.0 ... 26.0	
M 50 x 1.5			26.0 ... 35.0	25.0 ... 31.0	
M 63 x 1.5			34.0 ... 45.0	-	

6.2.3 Terminal boxes, end shields, grounding conductors, sheet metal fan covers

If no other tightening torques are specified, then the values in the following table apply.

Table 6-5 Tightening torques for screws on the terminal box, end shields, screw-type grounding conductor connections

		Thread Ø	M 3.5	M 4	M 5	M 6	M 8	M 10	M 12	M 16	M20
		N m	min	max	min	max	min	max	min	max	min
		0.8	2	3.5	6	16	28	46	110	225	
		1.2	3	5	9	24	42	70	165	340	

Note

Tightening torque for the condensation drain plug

Tighten the condensation drain plug M6x0.75 with a torque between 1.5 and 2.0 Nm!



Table 6-6 Tightening torques for self-tapping screws on the terminal box, end shields, screw-type grounding conductor connections, sheet metal fan covers

	Thread Ø		M 4	M 5	M 6
	Nm	min	4	7,5	12,5
		max	5	9,5	15,5

6.3 Connecting the grounding conductor

The machine's grounding conductor cross-section must comply with EN / IEC 60034-1.

Please also observe installation regulations such as those specified in EN / IEC 60204-1.

6.3.1 Grounding connection type

Enclosure grounding method		Cable cross-section [mm ²]
Connection of an individual conductor under the external grounding bracket.		... 10
Connection is made using a DIN cable lug under the external grounding bracket. DIN 46 234		... 25

Table 6-7 Minimum cross-sectional area of grounding conductor

Minimum cross-sectional area of phase conductor for installation S [mm ²]	Minimum surface area of associated grounding connection [mm ²]
S ≤ 16	S
16 < S ≤ 35	16
S > 35	0.5 S

Table 6-8 Screw size of the grounding cable, external grounding

Frame size	Thread size for the grounding conductor
63 ... 90	M4/ M5
100 ... 112	M5
132 ... 180	M6
200 ... 225	M8
200 1LG, 1LE15/6, 1FP1, 1MB15/6	2x M6
225 ... 315 1LG, 1LE15/6, 1MA, 1MB15/6	2x M8

6.4 Conductor connection

Cross-sections that can be connected depending on the size of the terminal (possibly reduced due to size of cable entries)

Table 6-9 Max. conductor connection for standard machines and Zone 22

Frame size	Max. connectable conductor cross-section [mm ²]
63 ... 90	1,5 2.5 with cable lug
100 ... 112	4,0
132	6,0
160 ... 180	16,0
200	25,0
225	35.0 with cable lug
250 ... 280	120,0
315	240,0

Table 6-10 Max. conductor connection for explosion-proof machines (with the exception of Zone 22) and VIK standard version



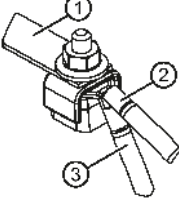
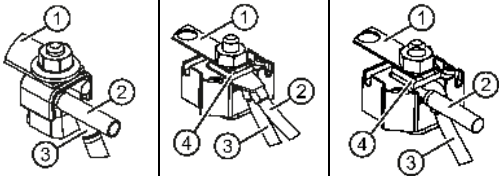
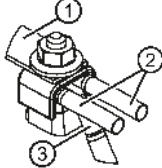

Frame size	Max. connectable conductor cross-section [mm²]
63 ... 112	4,0
132	6,0
160	16,0
180	10,0
180 (1LG4, 1LG6)	16,0
200 ... 225	50,0
250 ... 280	120,0
315	240,0

6.4.1 Type of conductor connection

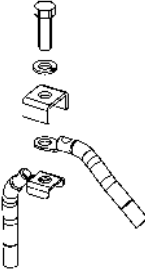
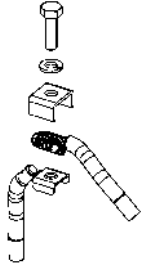
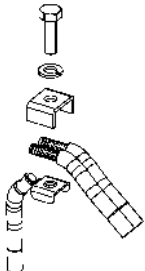
Terminal board	Conductor cross-section [mm ²]
<p>Connection with cable lug DIN 46 234 Bend down the cable lug for the connection.</p>	 <p style="text-align: right;">... 25</p>
<p>Connection of an individual conductor with terminal clamp</p>	 <p style="text-align: right;">... 10</p>
<p>Connection of two conductors of approximately the same thickness with terminal clamp</p>	 <p style="text-align: right;">... 25</p>

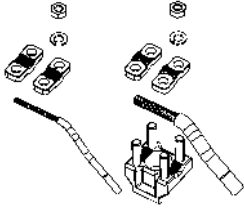
- ① Link rail
- ② Power supply cable
- ③ Motor connecting cable
- ④ Cover washer

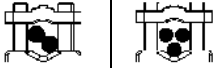
Terminal board			Conductor cross-section [mm ²]
Bend down the cable lug for the connection!	1MA618.		... 10
	1MA620.		... 35
Connection of an individual conductor with terminal clamp	1MA618. ... 20.		... 25
Connection of two conductors of the same thickness with terminal clamp	1MA618. ... 20.		... 25

Connection terminal 1MA6, 1MB153., 1MB163. and 1LG4/6 in type of protection Ex nA.			Conductor cross-section [mm ²]
	Frame size/option		
	18. ... 22.		2,5 ... 25
	25. ... 28.		10 ... 95
	31.		25 ... 135
	31. + L00 / R50		50 ... 300
	18. ... 22.		... 16
	25. ... 28.		... 35
	31.		... 70
	31. + L00 / R50		... 120
	18. ... 22.		16 ... 50
	25. ... 28.		50 ... 120
	31.		95 ... 240
	31. + L00 / R50		120 ... 400

6.5 Connecting converters



NOTICE

Excessively high supply voltage

Material damage can occur if the supply voltage is too high for the insulation system.

The machines can be operated with line voltages ≤ 500 V with SINAMICS G converters and SINAMICS S converters (uncontrolled and controlled infeed) when maintaining the permissible peak voltages.

The maximum permissible voltage rate of rise (gradient) is 9 kV/ μ s.

$\dot{U}_{\text{conductor-conductor}} \leq 1500$ V; $\dot{U}_{\text{conductor-ground}} \leq 1100$ V

For VSD machines, the following data apply:

$\dot{U}_{\text{conductor-conductor}} \leq 1600$ V, $\dot{U}_{\text{conductor-ground}} \leq 1400$ V, voltage rise times of $t_s > 0.1$ μ s.

See the list of additional operating instructions.



 **WARNING**

Machine overheating

Operating explosion-protected machines at the converter without using the appropriate protective equipment can result in death or severe injury.

Always use PTC thermistor monitoring when operating explosion-protected machines at the converter. Tripping units according to directive 94/9/EC are always necessary when using PTC thermistor monitoring.

Machines with non-sparking "nA" type of protection

The operation of the explosion-proof machines on the converters is permitted, when the specifications for the speed control range and torque characteristic are observed, and if winding temperature monitoring is ensured via the integrated temperature sensors in conjunction with a certified tripping unit.

Machines with increased safety "e" type of protection

Converter operation for these machines must be expressly certified. It is essential that you observe the separate manufacturer's information and instructions. Converter and protective devices must be marked as belonging together and the permitted operating data must be defined in the common EC-type examination certificate.

Machines connected to converters for Zone 21 and Zone 22

These machines are generally equipped with three PTC thermistors in accordance with DIN 44082 with a rated response temperature that depends on the maximum possible surface temperature. Select the PTC thermistors in accordance with this standard. The maximum temperature at the cable entries is 120 °C. Use suitable cables for this temperature. Do not exceed the maximum frequency dependent on the number of poles, which is stamped on the rating plate.

System, converter - cable - electrical machine

Please observe the information in accordance with EN / IEC 60034-17 and EN / IEC 60034-25 regarding winding stress. For line supplies with operating voltages up to 690 V, the maximum value of the voltage peaks at the end of the cable must not exceed twice the value of the converter's DC-link voltage.

6.6 Final checks

Before closing the terminal box/terminal base of the machine enclosure, check the following:

- Establish the electrical connections in the terminal box in accordance with the details in the sections above and tighten with the correct torque.
- Maintain air clearances between non-insulated parts:
 ≥ 5.5 mm up to 690 V, ≥ 8 mm up to 1000 V.
- Avoid protruding wire ends!
- In order not to damage the cable insulation, freely arrange the connecting cables.
- Connect the machine corresponding to the specified direction of rotation.
- Keep the inside of the terminal box clean and free from trimmed-off ends of wire.
- Ensure that all seals and sealing surfaces are undamaged and clean.
- Correctly and professionally close unused openings in the terminal boxes.



Before closing the terminal box, check that

- the air clearances for explosion-protected machines (with the exception of machines for Zone 22) between non-insulated parts are maintained: ≥ 10 mm to 690 V.
- the minimum creepage distance for explosion-protected machines (with the exception of machines for Zone 22) between non-insulated parts is maintained: ≥ 12 mm to 690 V.

7 Commissioning

When carrying out any work on the machine, observe the general safety instructions (Page 77) and the specifications contained in EN 50110-1 regarding safe operation of electrical equipment.

7.1 Setpoint values for monitoring the bearing temperature

Prior to commissioning

If the machine is equipped with bearing thermometers, set the temperature value for disconnection on the monitoring equipment before the first machine run.

Table 7-1 Set values for monitoring the bearing temperatures before commissioning

Set value	Temperature
Alarm	115 °C
Shutting down	120 °C

Normal operation

Measure the normal operating temperature of the bearings T_{op} at the installation location in °C. Set the values for shutdown and warning corresponding to the operating temperature T_{op} .

Table 7-2 Set values for monitoring the bearing temperatures

Set value	Temperature
Alarm	$T_{operation} + 5 K \leq 115 \text{ °C}$
Shutting down	$T_{operation} + 10 K \leq 120 \text{ °C}$

7.2 Measures before commissioning

NOTICE

Damage to the machine

In order to avoid material damage, check the following points before commissioning the motor:

- Using appropriate measures, check whether the correct direction of rotation of the motor has been set by the customer, e.g. by decoupling from the driven load.
- Ensure that temperature-sensitive parts (cables, etc.) are not in contact with the machine enclosure.
- Ensure that the condensation drain holes are always located at the lowest part of the motor.

NOTICE

Damage caused by insufficient cooling

Effective cooling is no longer possible if air guidance of the machine is not provided as intended. This can damage the machine.

- Before commissioning, attach the covers to guarantee the intended air guidance.

Measures

Once the system has been correctly installed, you should check the following prior to commissioning:

- Ensure that the machine has been correctly installed and aligned.
- Connect the machine corresponding to the specified direction of rotation.
- Ensure that the operating conditions match the data specified on the rating plate.
- Lubricate the bearings, depending on the version. Ensure that machines with roller bearings, which have been stored for longer than 24 months, are relubricated.
Also observe the notes in Chapter Preparation for use (Page 89).
- Ensure that any optional supplementary machine monitoring equipment has been connected correctly and is functioning as it should.
- For versions with bearing thermometers, check the bearing temperatures when the machine starts to run for the first time. Set the values for alarm and shutdown at the monitoring device. Also observe the notes in Chapter Setting values for monitoring the bearing temperature (Page 123).

- Corresponding to the control and speed monitoring functions implemented, ensure that the machine cannot exceed the permissible speeds specified on the rating plate.
- Ensure the correct setting conditions of the drive output elements depending on the type (e.g. alignment and balancing of couplings, belt forces in the case of a belt drive, tooth forces and tooth flank backlash/play in the case of gear wheel output, radial and axial clearance in the case of coupled shafts).
- Comply with the minimum insulation resistances and minimum air clearances.
- Ensure correct grounding and potential bonding connection of the protective conductor.
- Tighten all mounting bolts, connection elements and electrical connections to the specified torques.
- Remove any lifting eyes that were screwed after installation – or secure them to prevent them becoming loose.
- Rotate the rotor to ensure that it does not touch the stator.
- Implement all touch protection measures for both moving and live parts.
- Ensure that free shaft extensions cannot be touched, e.g. by attaching covers.
- Secure any featherkeys so that they cannot be flung out.
- Ensure that the optional external fan is ready for operation and connected so that it rotates in the specified direction.
- Ensure that the cooling airflow is not obstructed or diminished in any way.
- If an optional brake is being used, ensure that it is functioning perfectly.
- Comply with the specified mechanical limit speed n_{max} , and ensure that it is not exceeded.

If the design of the machine requires the converter to be assigned in a particular way, the relevant information will be provided on the rating plate or an additional label.

Note

It may be necessary to perform additional checks and tests in accordance with the specific situation on site.

See also

Observing the operating mode (Page 89)

8 Operation

When carrying out any work on the machine, observe the general safety instructions (Page 77) and the specifications contained in EN 50110-1 regarding safe operation of electrical equipment.

Switching on the machine



 **DANGER**

Hazardous voltages

Electrical machines are at hazardous voltage levels. Contact with these can result in death, serious injury or material damage.

Operating the machine on a line supply system with a non-grounded neutral point is only permitted for short periods of time that occur rarely, e.g. the time leading to a fault being eliminated. Cable ground fault EN / IEC 60034-1.

NOTICE

Damage to the machine or premature bearing failure

The bearings can be damaged if the following is not observed.

- It is absolutely crucial that you maintain the permissible vibration values to avoid damage to the machine or its destruction.
- In operation, observe the vibration values in accordance with ISO 10816.
- Under all circumstances maintain the minimum radial load of cylindrical roller bearings of 50% corresponding to what is specified in the catalog.
- Take the appropriate measures to reduce bearing currents. Observe the Chapter Converter operation.

 **WARNING****Faults in operation**

Changes with respect to normal operation indicate that there is an impaired function. This can cause faults which can result in eventual or immediate death, severe injury or material damage.

For instance, observe the following signs that could indicate a malfunction:

- Higher power drawn than usual
- Higher temperatures than usual
- Unusual noises
- Unusual smells
- Response of monitoring equipment

Immediately contact the maintenance personnel if you identify any irregularities. If you are in doubt, immediately switch off the machine, being sure to observe the system-specific safety conditions.

NOTICE**Risk of corrosion due to condensation**

If the machine and/or ambient temperatures fluctuate, this can result in condensation inside the machine.

- If available, remove the drain plugs or screws to drain the water depending on the ambient and operating conditions.
- If available, re-attach the drain plugs or screws.

If the motor is equipped with drain plugs, then the water can drain away by itself.

Switching on the machine with anti-condensation heating (optional) **CAUTION****Machine overheating**



Minor injury or material damage can occur if you do not observe the following:

- If available, switch off the anti-condensation heating each time before switching on.

See also

Converter operation (Page 94)

8.1 Safety information for explosion-protected machines in operation

 WARNING
Explosion hazard
 These explosion-protected machines are not suitable for hybrid explosive environments. This can result in death, serious injury or material damage. Use in atmospheres where there is a risk of explosion caused by both gas and dust simultaneously is absolutely prohibited.



Only install machines with type of protection increased safety "e", and machines for Zone 2 in hazardous areas, according to the regulations laid down by the responsible regulatory body. They are responsible for determining the hazard level of each area (division into zones). Layers of dust on machines for Zone 21 and Zone 22 must – under no circumstances – be higher than 5 mm!

- If there are no other specifications in the EC or EU-type examination certificate or on the rating plate regarding operating mode and tolerance, electrical machines are designed for continuous duty and normal starting procedures that are performed infrequently and do not result in excessive temperature rise. Only use these machines for the operating mode specified on the rating plate.
- Measures for maintaining the temperature class:
For machines equipped with their own fan and S1 line supply operation, a function-tested, current-dependent protective device that monitors all three phase conductors provides sufficient protection for the machine. This protective device is set to the rated current and must switch off machines with 1.2x the rated current within 2 hours or less. Do not switchoff for 1.05-fold or smaller rated current. Pole-changing machines require a separate switch for each pole number; further, temperature monitoring using PTC thermistors is required. If an anti-condensation heating system is available, it may only be switched on when the machines are not in operation.

8.2 Safety instructions for cleaning

Cleaning

To ensure problem-free machine cooling, the air ducts (ventilation grilles, channels, cooling fins, tubes) must be free of pollution.

WARNING

Risk of explosion when cleaning with compressed air

If you clean the machine with compressed air, plastic components may become statically charged and ignite a potentially explosive atmosphere; an explosion can occur. This can result in death, serious injury or material damage.

- Do not use compressed air to clean motors when installed in hazardous zones!

8.3 Stoppages

Longer non-operational periods

Note

- For longer non-operational periods (> 1 month), either operate the machine or at least turn the rotor regularly, approximately once per month.
- Please refer to the section "Switching on" before switching on to recommission the motor.
- Remove any machine rotor locking devices before you turn the rotor.

NOTICE

Restricted motor function

If not used for longer periods of time, material damage or complete motor failure can occur.

If the motor is out of service for a period of more than 12 months, then environmental effects can damage the motor.

- Apply suitable corrosion protection, preservation, packing and drying measures.

Switching on the anti-condensation heater

Switch on any anti-condensation heating while the machine is not being operated.

Taking the machine out of service

Details regarding the necessary measures, Chapter Preparing for use (Page 89).

Lubricating before recommissioning

NOTICE

Dry running bearings

Bearings can be damaged if they do not have sufficient grease.

- Re-grease the bearings if they have been out of service for more than one year. The shaft must rotate so that the grease can be distributed in the bearings. Observe the data on the lubricant plate.

Chapter Bearings (Page 140).

8.4 Fault tables

Note

Before removing any faults, please read the information in Chapter Safety notes (Page 77).

Note

If you operate the motor with a converter, and an electrical fault occurs, then also observe the information in the converter operating instructions.

The tables below list general faults caused by mechanical and electrical influences.

Table 8-1 Electrical influences

						Electrical fault characteristics	
↓						Machine will not start up	
↓						Machine starts up reluctantly	
↓						Rumbling noise during startup	
↓						Rumbling noise during operation	
↓						Overheating during no-load operation	
↓						Overheating when under load	
↓						Overheating of individual winding sections	
						Possible causes of faults	Remedial measures¹⁾
X	X		X		X	Overload	Reduce load
X						Interruption of a phase in the supply line	Check switches and supply lines
	X	X	X		X	Interruption of a phase in the supply line after switching on	Check switches and supply lines
X	X					Supply voltage too low, frequency too high	Check power supply conditions
				X		Supply voltage too high, frequency too low	Check power supply conditions
X	X	X	X		X	Stator winding incorrectly connected	Check winding connections
	X	X	X		X	Winding short circuit or phase short circuit in stator winding	Measure the winding resistances and insulation resistances, repair after consultation with manufacturer
					X	Incorrect direction of rotation of axial fan	Check connections

(1) As well as eliminating the cause of the fault (as described under "Remedial measures"), you must also rectify any damage the machine may have suffered.

Table 8-2 Mechanical effects

				Mechanical fault characteristics	
			↓	Grinding noise	
			↓	Overheating	
			↓	Radial vibrations	
			↓	Axial vibrations	
				Possible causes of faults	Remedial measures¹⁾
X				Rotating parts are grinding	Determine cause and adjust parts concerned
	X			Reduced air supply, fan possibly rotating in the wrong direction	Check airways, clean machine
		X		Rotor not balanced.	Check feather key declaration (H, F, N)
		X		Rotor out of true, shaft bent	Please consult the manufacturer.
		X	X	Poor alignment	Align machine set, check coupling. ²⁾
		X		Coupled machine not balanced	Re-balance coupled machine
		X		Surges from coupled machine	Inspect coupled machine
		X	X	Imbalance originating from gearing	Adjust/repair gearing
		X	X	Resonance in the overall system (comprising machine and foundation)	Reinforce foundation following consultation
		X	X	Changes in foundation	Determine cause of changes; eliminate if necessary; realign machine



1) As well as eliminating the cause of the fault (as described under "Remedial measures"), you must also rectify any damage the machine may have suffered.

2) Note any changes that take place while the temperature is rising.

9 Maintenance

When carrying out any work on the machine, observe the general safety instructions (Page 77) and the specifications contained in EN 50110-1 regarding safe operation of electrical equipment.

9.1 Safety instructions for inspection and maintenance

 WARNING
Rotating and live parts Electric machines contain live and rotating parts. Fatal or serious injuries and substantial material damage can occur if maintenance work is performed on the machine when it is not stopped or not de-energized. <ul style="list-style-type: none">• Perform maintenance work on the machine only when it is stopped. The only operation permissible while the machine is rotating is regreasing the roller bearings.• When performing maintenance work, comply with the five safety rules.
 WARNING
Machine damage If the machine is not maintained it can suffer damage. This can cause faults which can result in eventual or immediate death, serious injury or material damage. Perform regular maintenance on the machine.
 CAUTION
Dust disturbances when working with compressed air When cleaning with compressed air, dust, metal chips, or cleaning agents can be whirled up. Injuries can result. When cleaning using compressed air, make sure you use suitable extraction equipment and wear protective equipment (safety goggles, protective suit, etc.).

NOTICE

Damage to insulation

If metal swarf enters the winding head when cleaning with compressed air, this can damage the insulation. Clearance and creepage distances can be undershot. This may cause damage to the machine extending to total failure.

When cleaning with compressed air, ensure there is adequate extraction.

NOTICE

Machine damage caused by foreign bodies

Foreign bodies such as dirt, tools or loose components, such as screws etc., can be left by accident inside the machine after maintenance is performed. These can cause short circuits, reduce the performance of the cooling system or increase noise in operation. They can also damage the machine.

- When carrying out maintenance work, make sure that no foreign bodies are left in or on the machine.
- Securely attach all loose parts again once you have completed the maintenance procedures.
- Carefully remove any dirt.

Note

Operating conditions and characteristics can vary widely. For this reason, only general intervals for inspection and maintenance measures can be specified here.

9.2 Preparation and notes

9.2.1 Paint finish resistant to sea air

WARNING

Risk of explosion as a result of processes with high levels of electrostatic charging

Carefully observe the appropriate precautionary measures in order to avoid death or severe injury.

For paint finish "resistant to sea air" (C4 according to EN ISO 12944-2) for motors belonging to explosion group III, processes that generate significant levels of electrostatic discharge are absolutely not permissible. Paint can be electrostatically charged as a result of intensive dust turbulence or processes with high levels of electrostatic charging. Electrostatic discharges can occur. Minimize the risk of electrostatic charging by applying the following effective measures.

- Increase the conductivity of bulk goods and plant/system parts, e.g. by applying an appropriate coating.
- Increase the humidity or ionization.
- Reduce the amount of fine components in bulk goods, e.g. resulting from abrasion
- Restrict the degree of dispersion, e.g. by selecting plug conveying instead of dilute phase conveying.
- Reduce the flow rate, the mass flow rate or the air velocity.
- Avoid large heaps of bulk goods.
- Transport using gravity is the preferred choice rather than pneumatic transport.
- When pneumatically transporting bulk goods, use conductive hoses in order to avoid electrostatic discharge.

Additional measures are listed in IEC 60079-32-1.

9.2.2 Repainting

WARNING

Explosion hazard caused by incorrect painting

The paint coat can become electrostatically charged where there is a thick coat. Electrostatic discharges can occur. There is a risk of explosion if potentially explosive mixtures are also present at this moment. This can result in death, serious injury or material damage.

You must comply with one of the following requirements when you repaint painted surfaces:

- Limit the total paint film thickness according to the explosion protection group:

- IIA, IIB: Total paint coating thickness ≤ 2 mm
- IIC: Overall coating thickness ≤ 0.2 mm for motors of group II (gas)
- Limit the surface resistance of the paint used:
 - Surface resistance ≤ 1 G Ω for motors of groups II and III (gas and dust)
- Charge transfer limit
 - 60 nC for Group I or Group IIA devices
 - 25 nC for Group IIB devices
 - 10 nC for Group IIC devices
 - 200 nC for Group III devices (values not valid for strongly charge generating processes)
- Breakdown voltage ≤ 4 kV for explosion group III (gas and dust)

9.2.3 Warning when repainting

 WARNING
Risk of explosion as a result of processes with high levels of electrostatic charging For paint finishes in explosion group III, the paint can be electrostatically charged as a result of intensive dust turbulence or processes with high levels of electrostatic charging. Electrostatic discharges can occur. Minimize the risk of electrostatic charging by applying effective measures according to IEC 60079-32-1. This can result in death, serious injury or material damage.

Note

Paint finishes for IIC are optionally available with more than 200 μm coat thickness. Paint finishes exceeding 200 μm are tested with respect to electrostatic charging. Motors with a coating thickness exceeding 200 μm may only be painted over if the conditions mentioned above are complied with.

9.3 Inspection

Notes

Note

Pay particular attention to the relubrication intervals for rolling bearings that deviate from the inspection intervals.

Note

When servicing a three-phase machine, it is generally not necessary to dismantle it. The machine only has to be dismantled if the bearings are to be replaced.

9.4 Maintenance

9.4.1 Re-greasing

For machines with regreasing system, relubrication intervals, grease quantity and grease grade are provided on the lubricant plate. Additional data can be taken from the main machine rating plate.

Grade of grease for standard motors (IP55) UNIREX N3 - ESSO.

Note

It is not permissible to mix different types of grease.

Prolonged storage periods reduce the useful lifetime of the bearing grease. Check the condition of the grease if the equipment has been in storage for more than 12 months. If the grease is found to have lost oil content or to be contaminated, the machine must be immediately relubricated before commissioning. For information on permanently-greased bearings, please refer to the section titled Bearings (Page 140).

Procedure

To relubricate the roller bearings, proceed as follows:

1. Clean the grease nipples at the drive end and non-drive end.
2. Press-in the specified grease and amount of grease according to the data stamped on the lubrication plate.
 - Please observe the information on the rating and lubricant plates.
 - Regreasing should be carried out when the motor is running (max. 3600 rpm).

The bearing temperature can rise significantly at first, and then drops to the normal value again when the excess grease is displaced out of the bearing.

9.4.2 Cleaning

Cleaning the grease ducts and spent grease chambers

The spent grease collects outside each bearing in the spent grease chamber of the outer bearing cap. When replacing bearings, remove the spent grease.

Note

Dismantle the bearing cartridges to replace the grease in the lubrication duct.

Cleaning the cooling air ducts

Regularly clean the cooling air ducts through which the ambient air flows.

The frequency of the cleaning intervals depends on the local degree of fouling.

NOTICE
Damage to the machine Material damage can occur if you direct compressed air in the direction of the shaft outlet or machine openings. <ul style="list-style-type: none">• Avoid pointing compressed air directly onto shaft sealing rings or labyrinth seals of the machine.

Note

Please note the safety instructions for cleaning (Page 129).

9.4.3 Drain condensate

If there are condensation drain holes present, open these at regular intervals, depending on climatic conditions.



 **WARNING**

Hazardous voltage

The winding can be damaged if objects are introduced into the condensation holes (optional). This can lead to death, serious injury or material damage.

Note the following to maintain the degree of protection:

- Switch off the machine so that it is in a no-voltage condition before you open the condensation drain holes.
- Close the condensation drain holes, e.g. using T-plugs, before commissioning the machine.

NOTICE

Reduction of the degree of protection

If condensation drain holes are not closed, then this can result in material damage to the motor.

In order to maintain the degree of protection, after the condensation has been drained, you must close all of the drain holes.

9.5 Repair

When carrying out any work on the machine, observe the general safety instructions (Page 77) and the specifications contained in EN 50110-1 regarding safe operation of electrical equipment.



Comply with the IEC / EN 60079-17 standard during all service and maintenance work on the machine.

 **WARNING**

Explosion hazard when carrying out repair work

Repairs are only permissible within the scope of the work described in these operating instructions. Otherwise an explosion can occur in an explosive atmosphere. This can result in death, serious injury or material damage.

For repairs to go beyond this scope, please contact the Service Center.

 WARNING
<p>Explosion hazard due to increased surface temperature</p> <p>Components within the motor may be hotter than the maximum permissible surface temperature for the enclosure. In an explosive atmosphere, dust can ignite and an explosion occur. This can result in death, serious injury or material damage.</p> <ul style="list-style-type: none"> • Do not open the motor in an explosive and dusty atmosphere when it is still at normal operating temperature. • Allow the machine to cool down before opening it.

9.5.1 Bearings

Refer to the rating plate or the catalog for the designations of the bearings being used.

Bearing lifetime

Prolonged storage periods reduce the useful lifetime of the bearing grease. For permanently lubricated bearings, this reduces the bearing service life. We recommend that the bearings or grease are replaced after a storage time of 12 months; if the time exceeds 4 years, replace the bearings or the grease.

Replacing bearings

Recommended interval after which bearings are to be replaced under normal operating conditions:

Table 9-1 Bearing replacement intervals

Ambient temperature	Principle of operation	Bearing replacement intervals
40 °C	Horizontal coupling operation	40 000 h
40 °C	With axial and radial forces	20 000 h

- Do not reuse bearings that have been removed.
- Remove the dirty spent grease from the bearing shield.
- Replace the existing grease with new grease.
- Replace the shaft seals when the bearings are replaced.

- Slightly grease the contact surfaces of the sealing lips.

Note**Special operating conditions**

The operating hours are reduced, e.g.

- When machines are vertically mounted.
 - High vibration and surge loads
 - Frequent reversing operation
 - Higher ambient temperatures.
 - High speeds etc.
-

9.5.1.1 Replacing bearings in explosion-proof machines

- When changing the bearings, renew the sealing rings and only use original Siemens spare parts.
- For radial sealing rings with dust protection lip (DIN 3760-AS), completely fill the spaces (100%) in the sealing ring as well as in the bearing shield hub with a suitable grease.

9.6 Disassembly

Note

Before commencing removal, you should mark how each of the fastening elements has been assigned, as well as how internal connections are arranged. This simplifies subsequent reassembly.

Fan**NOTICE****Destruction of the fan**

Material damage can occur by forcefully removing the fan from the shaft.

Take care not to damage the snapping mechanisms on fans that are equipped with these.

Plastic fan

- Correctly expose the breakout openings provided in the fan plate
- Heat up the fans to a temperature of approximately 50 °C around the area of the hub.
- Use a suitable tool to pull off the fan (puller).

- Locate the arms of the pulling tool in the the breakout openings and slightly tension the pressure screw of the tool.
- Simultaneously release the two snap-in lugs of the fan from the shaft groove. Keep the snap-in lugs in this position.
- Uniformly withdraw the fan from the shaft by turning the pressure screw of the pulling tool.
- Do not apply any hammer blows to avoid damaging the rotor shaft, the fan and the bearings.
- Order the appropriate new parts if damaged.

Metal fan

- Remove the locking ring.
- Use a suitable tool to pull off the fan (puller).
- Locate the arms of the pulling tool in the openings in the fan in the vicinity of the hub.
- Alternatively, the pulling tool can be placed at the outer edge of the fan plate.
- Uniformly withdraw the fan from the shaft by turning the pressure screw of the pulling tool.
- Do not apply any hammer blows to avoid damaging the rotor shaft, the fan and the bearings.
- Order the appropriate new parts if damaged.

9.7 Reassembly

If possible, assemble the machine on and alignment plate. This ensures that the mounting feet surfaces are all on the same plane.

Avoid damaging the windings protruding out of the stator enclosure when fitting the end shield.

Sealing measures

1. Apply Fluid-D to the centering edge.
2. Check the terminal box seals, and if required, replace these.
3. Repair any damage to the paint, also to screws/bolts.
4. Take the necessary measures to ensure compliance with the applicable degree of protection.
5. Do not forget the foam rubber cover in the cable entry. Completely seal the holes, and ensure that cables do not come into contact with sharp edges.

9.7.1 Fitting bearings

Sealing the bearings

Note the following details:

- Shaft sealing rings are used to seal machines at the rotor shaft.
 - For V rings, comply with the assembly dimension.
- Use the specified bearings.
- Ensure that the bearing sealing disks are in the correct position.
- Insert the elements for bearing preloading at the correct end.
- Fixed bearings can have a locking ring or bearing cover.
- Seal the bearing cap screws with the appropriate gaskets or with grease.
- Do not interchange the position of the bearing covers (DE and NDE or inner and outer).



Note

Bearing seals for explosion-protected machines

For explosion-protected machines, only use the original replacement and repair parts.

Mounting dimension "x" of V rings

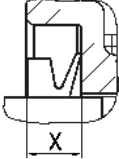
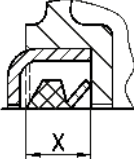
Motor types	Frame size	X [mm]	
All	71	4.5 ±0.6	Standard design 
	80 ... 112	6 ±0.8	
	132 ... 160	7 ±1	
180 ... 200			
1LA 1MA6	180 ... 200	11 ±1	
1FP1	180 ... 200		
1LG 1MA622 1LE 1MB1	180 ... 225	11 ±1	Special design 
1LG 1MA6 1LE 1MB1	250 ... 315	13.5 ±1.2	

9.7.2 Mounting fans

- Take care not to damage the snapping mechanisms on fans that are equipped with these.
- To ensure this, the fans should be heated to a temperature of approximately 50 °C around the area of the hub.
- If any damage is caused, request new parts.

9.7.3 Reassembly: Miscellaneous information

- Position all rating and supplementary plates as in the original state.
- Where relevant, fix electric cables.
- Check the tightening torques of all screws, as well as those of screws that have not been released.

10 Spare parts

10.1 Parts order

In addition to the exact part designation, please specify the machine type and the serial number in all orders for spare parts and repair parts. The part designation must be identical to the designation stated in the list of parts and specified together with the appropriate part number.

When spare and repair parts are ordered, the following details must be provided:

- Designation and part number
- Order number and serial number of the machine

Spare parts information and database

Using the Siemens order number and the associated serial number, you can download spare parts information from a database for almost all current motors → Spares On Web (https://b2b-extern.automation.siemens.com/spares_on_web)

A Service & support

A.1 Siemens Industry Online Support

Technical queries or additional information



If you have any technical queries or you require additional information, please contact Technical Support (<https://support.industry.siemens.com/cs/ww/en/sc/2090>).

Please have the following data ready:

- Type
- Serial number

You can find this data on the rating plate.

On-site service and spare parts

If you wish to request on-site service or order spare parts, please contact your local Siemens sales office. This office will contact the responsible service center on your behalf.

You can obtain optimum support everywhere using the SIOS App. The SIOS App is available for Apple iOS, Android and Windows phone.



A.2 Further documents

These operating instructions can also be obtained at the following Internet site:

<http://support.industry.siemens.com> (Page 145)

General Documentation

1.517.30777.30.000	1XP8001 encoder
5 610 00000 02 000	Operating_Instructions_Simotics GP, SD, DP, XP
5 610 00000 02 001	Operating_Instructions_Compact_Simotics GP, SD, DP
5 610 00000 02 002	Operating_Instructions_Compact_Simotics XP
5 610 00002 09 000	Incremental encoder 1XP8012-1x
5 610 00002 09 001	Incremental encoder 1XP8012-2x
5 610 70000 02 015	External fan
5 610 70000 10 020	Spring-loaded brake

Observe all of the other documents available for this machine.

Trademarks

All names identified by ® are registered trademarks of Siemens AG. The remaining trademarks in this publication may be trademarks whose use by third parties for their own purposes could violate the rights of the owner.

Disclaimer of Liability

We have reviewed the contents of this publication to ensure consistency with the hardware and software described. Since variance cannot be precluded entirely, we cannot guarantee full consistency. However, the information in this publication is reviewed regularly and any necessary corrections are included in subsequent editions.

Siemens AG
Division Process Industries and Drives
Postfach 48 48
90026 NÜRNBERG

Explosion-protected machines
56100000002002, 01/2016